



DLF2158-U / DLH2158-U V1

21.5" TFT LCD, LED Backlight 1600nits, FHD(1920x1080)

The DLF/DLH2158-U is a 21.5 inch industrial grade sunlight readable LCD, with high brightness 1600 nits and high color saturation, it produce sharp images, crisp text and lifelike colors. The Durapixel LED backlight technology ensures high reliability and low power consumption, suitable for outdoor application, kiosk, factory automation, military, transportation and gaming application.

Key Features

- High Brightness 1600 nits
- Sunlight Readable
- LED Backlight
- Low Power Consumption
- LCD Blanking Defect Free (Hi-Tni 110°C)
- BL MTBF: 100,000 hours



Specifications

Model Name	DLF2158-U / DLH2158-U V1
Description	21.5" TFT LCD, LED Backlight 1600 nits, FHD (1920x1080)
Screen Size	21.5"
Display Area (mm)	467.64(H) x 268.11(V)
Brightness	1600 cd/m ²
Resolution	1920x1080
Aspect Ratio	16 : 9
Contrast Ratio	2800 : 1
Pixel Pitch (mm)	0.24825(H) x 0.24825(V)
Pixel Per Inch (PPI)	102
Viewing Angle	178°(H),178°(V)
Color Saturation (NTSC)	80%
Display Colors	16.7M
Response Time (Typical)	25ms
Panel Interface	LVDS
AD Board Input Interface	VGA, DVI-D
AD Board Input Power	DC12V
Power Consumption	47W (52W with AD Board)
OSD Key	4 Keys (Power Switch, Menu, +, -)
OSD Control	Brightness, Color, Contrast, Auto Turing, H/V Position...etc
Dimensions (mm)	497.6 x 292.2 x 13.35
Bezel Size(U/B/L/R)	10.35/10.35/8.9/8.9 mm
Weight (Net)	1.8kg
Operating Temperature	0 °C ~ 60 °C
Storage Temperature	-20 °C ~ 60 °C

DLF= Panel + LED Driving Board

DLH= Panel + LED Driving Board + AD Control Board

*Specifications are subject to change without notice.
All brands or product names are trademarks or registered trademarks of their respective companies.*



Mechanical Drawing

Outline Dimensions

Unit:mm

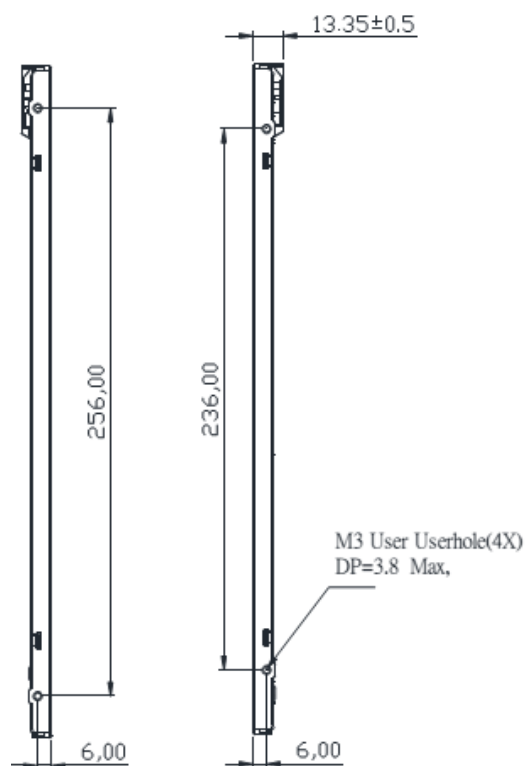
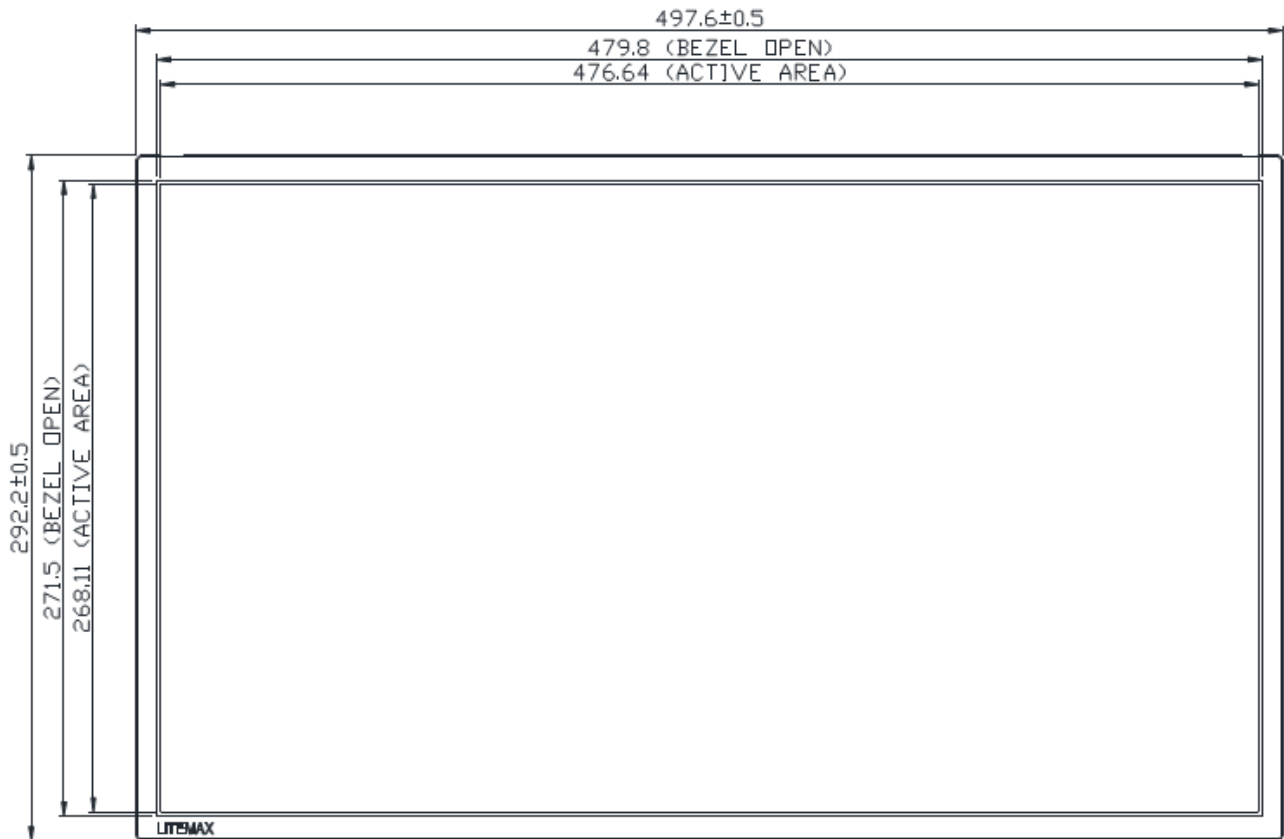

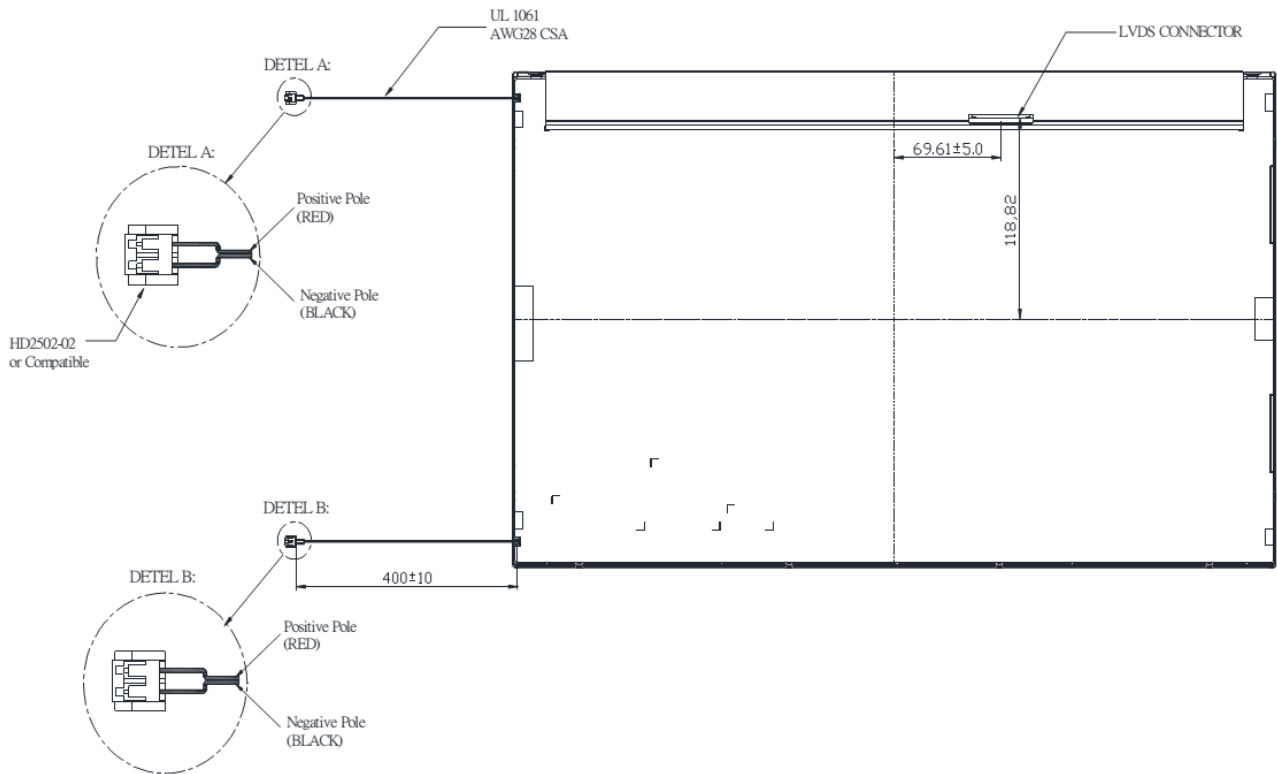

Note :

1. GENERAL TOLERANCE: ±0.5mm
2. ALLOW ED DEPTH OF USERHOLE SCREW INSERTION IS 3.8mm MAX.
3. USER SCREW TORQUE=4.0 kgf/cm MAX.



Ordering Information

Part Number	Description
DLF2158-UNN-A01	21.5",1600nits,FHD,LID21B,5in1,V1
DLH2158-UNN-G01	21.5",1600nits,FHD,LID21B,AD2662GD,DC12V,5in1,V1

Optional Accessories

Part Number	Description
840612051212	ADAPTER,AC/DC,12V/5 A,60W.Power-Din-4P,CWT.G99-ABF060F-N022.Efficiency-level-6,R
810618301010	CABLE.POWER.AC.1830mm USA type
810618301090	CABLE,POWER,AC,1830mm Europe type
810618301050	CABLE.POWER.AC.1830mm UK type
810618301170	CABLE.POWER,AC,1830mm Australia type
810618301031	CABLE.POWER.AC.1830mm Japan type

Customer request

Touch	SCT (Single-Touch), PCT (Multi-Touch)
Glass	Tempered glass, AR coating.....