



SSD1905-Y

19" LCD, 1000nits LED backlight, 1920 x 360 ultra-wide aspect ratio 16:3

The SSD1905-Y is a 19 inch color TFT-LCD display with special aspect ratio 16:3 and wide resolution 1920 x 360. It is Litemax's Spanpixel series product which designed for high brightness with power efficiency LED backlight. It provides LCD panel with specific aspect ratios and sunlight readable for digital signage, public transportation, exhibition hall, department store, and vending machine.

Key Features

- Ultra-Wide Screen (16 : 3)
- High Brightness
- Sunlight Readable
- LED Backlight
- Low Power Consumption

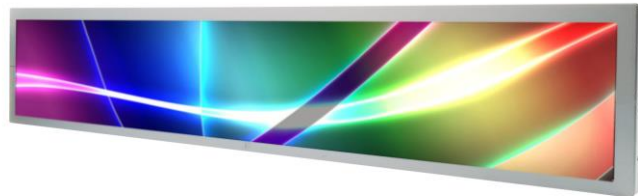

Specifications

Model Name	SSD1905-Y V1
Description	19" LCD, 1000nits LED backlight , 1920x360
Screen Size	19"
Display Area (mm)	476.64(H) x 89.37(V)
Brightness	1000 cd/m ²
Resolution	1920x360
Aspect Ratio	16 : 3
Contrast Ratio	1150 : 1
Pixel Pitch (mm)	0.2482(H) x 0.2482(V)
Pixel Per Inch (PPI)	103
Viewing Angle	178°(H),178°(V)
Color Saturation (NTSC)	84%
Display Colors	16.7M
Response Time (Typical)	30ms
Panel Interface	LVDS
AD Board Input Interface	VGA, DVI-D, HDMI
Input Power	DC12V
Power Consumption	17.5W
Dimensions (mm)	496.6x 114.6 x 45
Bezel Size(U/B/L/R)	14.3/9.3/9.3/9.3 mm
Weight (Net)	2.3 kg
Mounting	75x75, 250x75
Operating Temperature	0 °C ~ 50 °C
Storage Temperature	-20 °C ~ 60 °C

SSD= Panel + LED Driving Board + AD Control Board + Chassis

Specifications are subject to change without notice.

All brands or product names are trademarks or registered trademarks of their respective companies.

Mechanical Drawing



Outline Dimensions

Unit:mm

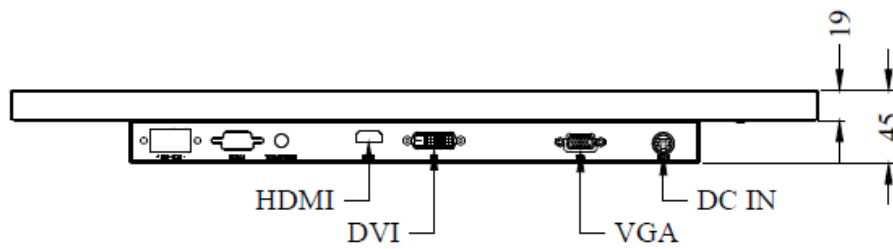
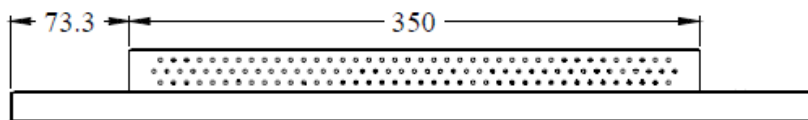
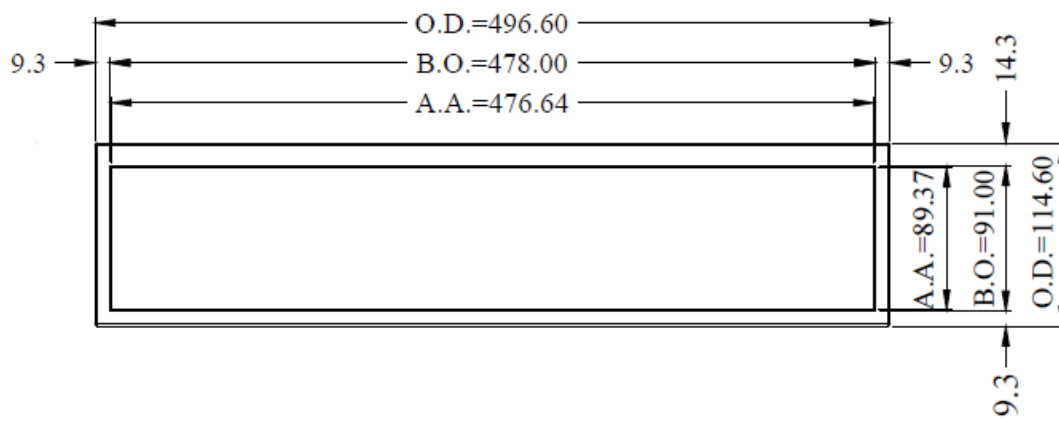
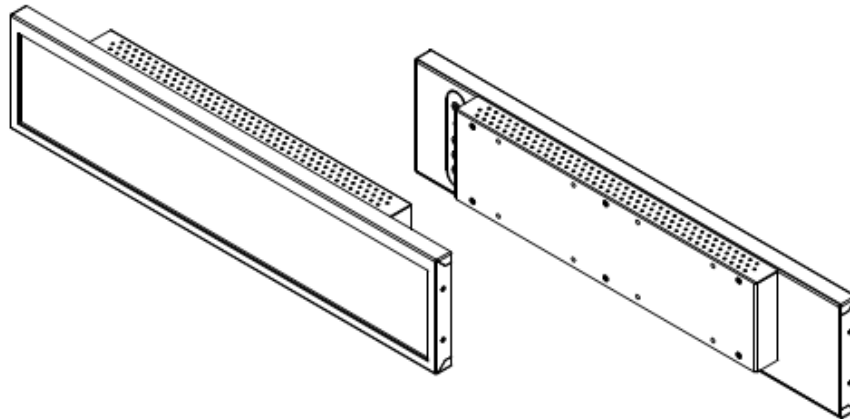

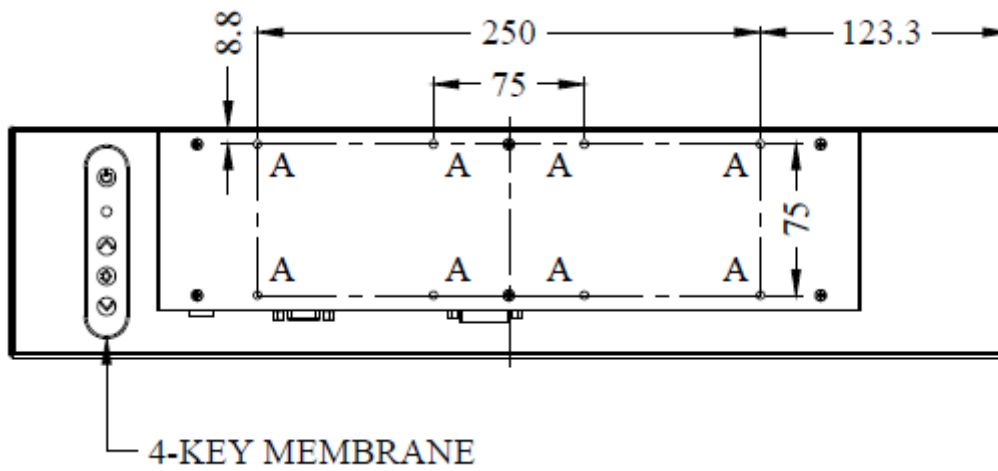
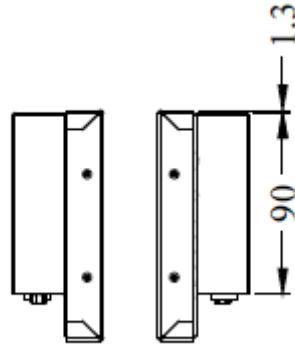

NOTE :

O.D. : OUTLINE DIMENSION

B.O. : BEZEL OPENING

A.A. : LCD ACTIVE AREA

A : 8-M4_USER HOLE_MAX DEPTH=6 mm



Ordering Information

Part Number	Description
SSD1905-YNB-G01	19",1000nits,1920*360,LID19A,AD2662GDHM,O/B,DC12V,3in1,V1

Optional Accessories

Part Number	Description
840612031101	ADAPTER.12V.3.33A.40W.G99-KPL040F-N051.DC Plug 2.1*5.5,P
810618301010	CABLE.POWER.AC.1830mm USA type
810618301090	CABLE,POWER,AC,1830mm Europe type
810618301050	CABLE.POWER.AC.1830mm UK type
810618301170	CABLE.POWER,AC,1830mm Australia type
810618301031	CABLE.POWER.AC.1830mm Japan type

Customer request

Touch	SCT (Single-Touch), PCT (Multi-Touch)
Glass	Tempered glass, AR coating.....