



SSD3205-A

32" TFT LCD, 1000 nits LED Backlight, 1920x1080, MaxRGB, Triangle Display

The SSD3205-A is a 32 inch color TFT-LCD display with special aspect ratio 16:9 and wide resolution 1920 x 1080. It is Litemax's Spanpixel series product which designed for high brightness 1000 nits with power efficiency LED backlight. It provides LCD panel with specific aspect ratios and sunlight readable for digital signage, public transportation, exhibition hall, department store, and vending machine.

Key Features

- Triangle Display
- Brightness 1000 nits
- High Color Saturation 94%
- Viewing Angle of 178°(H), 178°(V)
- LED Backlight
- Low Power Consumption
- BL MTBF: 100,000 hours

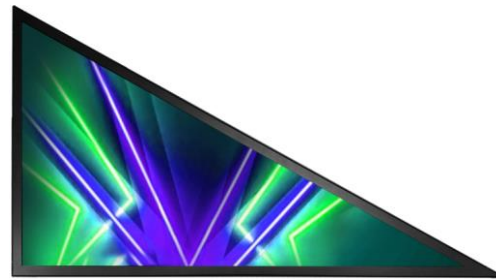

Specifications

Model Name	SSD3205-A
Description	32" TFT LCD, 1000nits LED Backlight, 1920x1080, MaxRGB, Triangle Display
Screen Size	32"
Display Area (mm)	698.4(H) x 392.85(V)
Brightness (Typical)	1000 cd/m2
Resolution	1920x1080
Aspect Ratio	16 : 9
Contrast Ratio (Typical)	4900 : 1
Pixel Pitch (mm)	0.36375(H) x 0.36375 (V)
Pixel Pre Inch (PPI)	69
Viewing Angle	178°(H),178°(V)
Color Saturation (NTSC)	94%
Display Colors	16.7M
Response Time (Typical)	8ms
Panel Interface	LVDS
Input Interface	HDMI, DP
Input Power	DC12V
Power Consumption	37W
OSD Key	4 Keys (Power Switch, Menu, +, -)
OSD Control	Brightness, Color, Contrast, Auto Turing, H/V Position...etc
Dimensions (mm)	753.72 x 437.86 x 48.2
Bezel Size(U/B/L)	15.82/18.14/18.14
Weight (Net)	3.7 kg
Operating Temperature	0 °C ~ 50 °C
Storage Temperature	-20 °C ~ 60 °C

SSD= Panel + LED Driving Board + AD Control Board + Classis

Specifications are subject to change without notice.

All brands or product names are trademarks or registered trademarks of their respective companies.



Mechanical Drawing

Outline Dimensions

Unit:mm

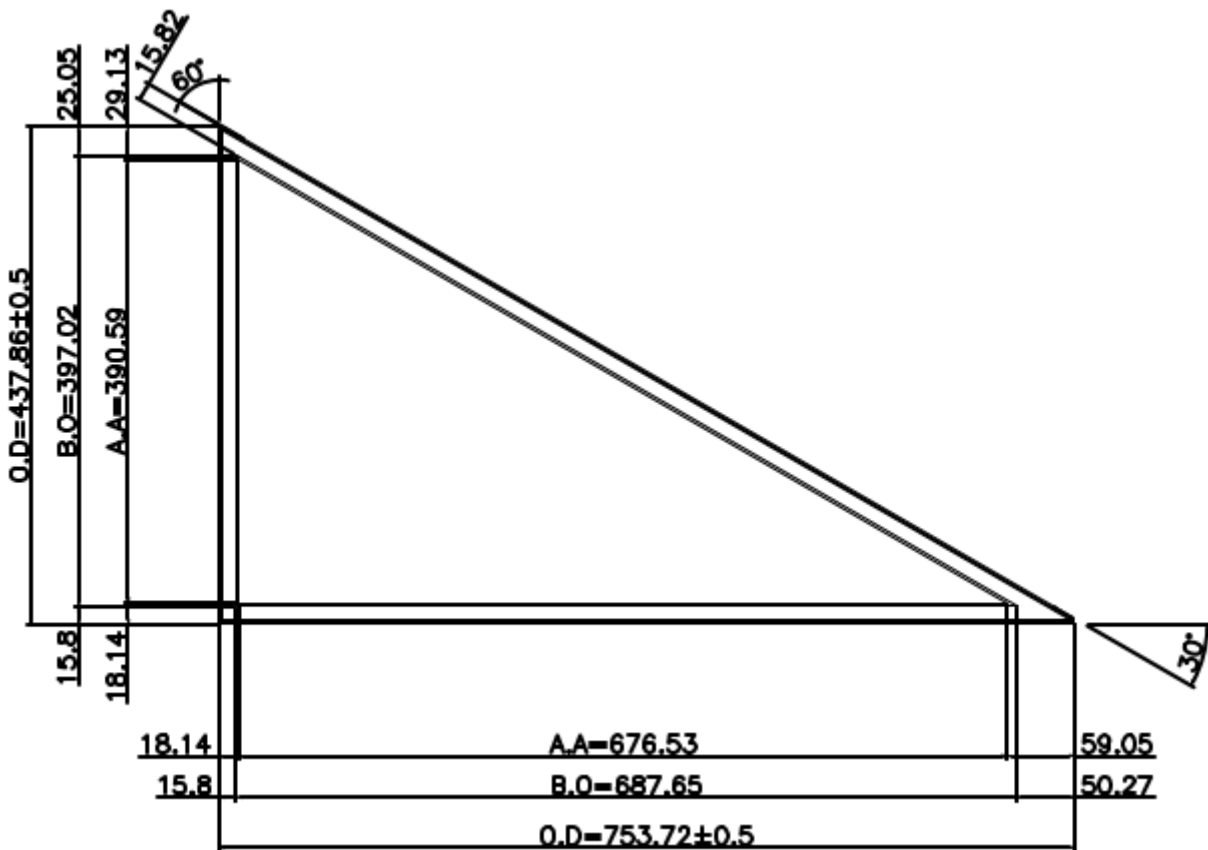
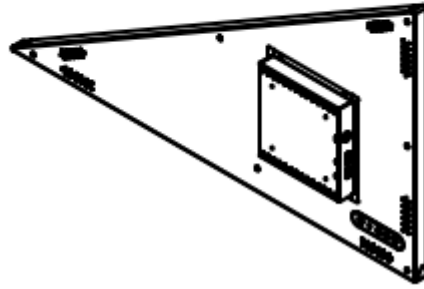
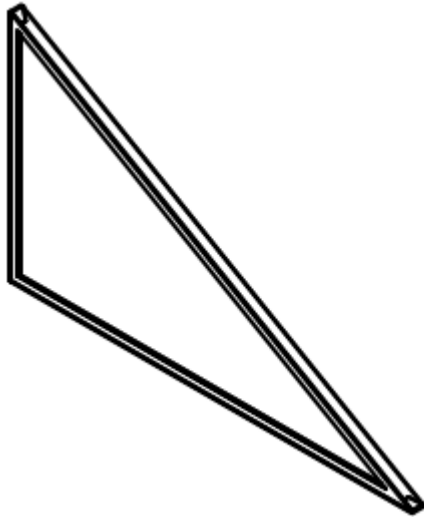

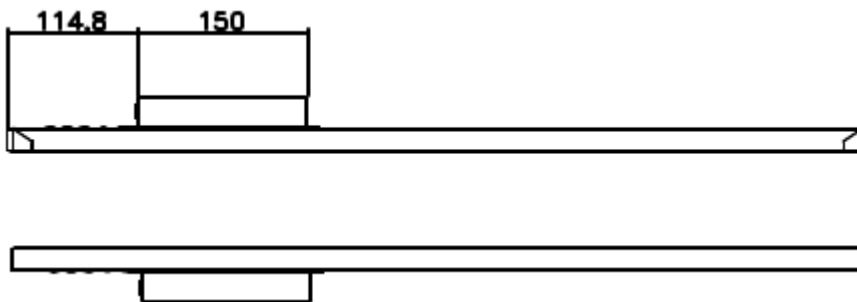
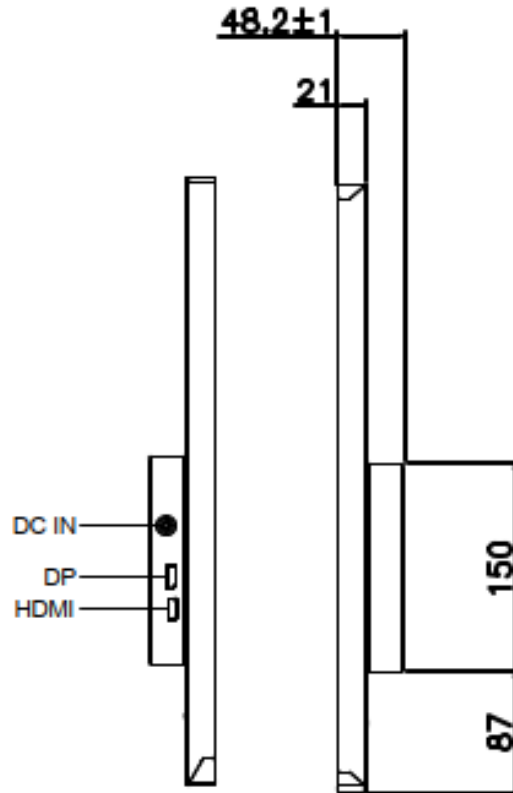

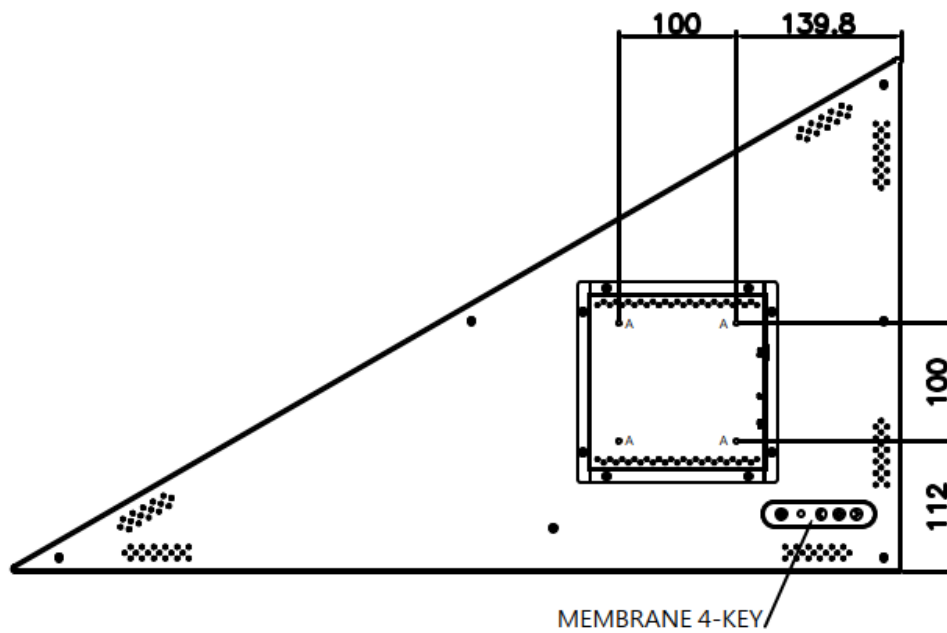

Note :
 O.D : Outline Dimension
 B.O : Bezel Opening
 A.A : LCD Active Area
 A:4-M4_USER_HOLE_MAX_DEPTH=6mm

Ordering Information

Part Number	Description
SSD3205-ANW-T11	32",1000nits,1920x1080,MaxRGB,Triangle,LID32C,AD68862HP,O/B,DC12V,V1

Optional Accessories

Part Number	Description
840612051212	ADAPTER,AC/DC,12V/5A,60W.Power-Din-4P,CWT.G99-ABF060F-N022.Efficiency-level-6,R
810618301010	CABLE,POWER,AC,1830mm USA type
810618301090	CABLE,POWER,AC,1830mm Europe type
810618301050	CABLE,POWER,AC,1830mm UK type
810618301170	CABLE,POWER,AC,1830mm Australia type
810618301031	CABLE,POWER,AC,1830mm Japan type

Customer request

Touch	PCT (Multi-Touch)
Glass	Tempered glass, AR coating.....