



SSD3585-Y V1

35.8" TFT LCD, 1000 nits LED Backlight , 1920x532 ultra-wide aspect ratio 16:4.4

The SSD3585-Y is a 35.8 inch color TFT-LCD display with special aspect ratio 16:4.4 and wide resolution 1920 x 532. It is Litemax's Spanpixel series product which designed for high brightness 1000 nits with power efficiency LED backlight. It provides LCD panel with specific aspect ratios and sunlight readable for digital signage, public transportation, exhibition hall, department store, and vending machine.

Key Features

- 35.8" Stretched LCD
- Ultra-Wide Screen (16 : 4.4)
- High Brightness 1000 nits
- LED Backlight
- Low Power Consumption
- BL MTBF: 50,000 hours



Specifications

Model Name	SSD3585-Y V1
Description	35.8" TFT LCD, 1000 nits LED backlight, 1920x532
Screen Size	35.8"
Display Area (mm)	878.112(H) x 239.081(V)
Brightness	1000 cd/m ²
Resolution	1920x532
Aspect Ratio	16 : 4.4
Contrast Ratio	4200 : 1
Pixel Pitch (mm)	0.45735(H) x 0.4494(V)
Pixel Pre Inch (PPI)	55
Viewing Angle	178°(H),178°(V)
Color Saturation (NTSC)	81%
Display Colors	16.7M
Response Time (Typical)	9.5ms
Panel Interface	LVDS
Input Interface	VGA,DVI-D,HDMI,DP
Input Power	DC 24V
Power Consumption	60W
OSD Key	4 Keys (Power Switch, Menu, +, -)
OSD Control	Brightness, Color, Contrast, Auto Turing, H/V Position...etc
Dimensions (mm)	898(H) x 268.1(V) x 77.2 (T)
Bezel Size(U/B/L/R)	14.5/14.5/9.9/9.9 mm
Mounting	300x75
Weight (Net)	10.5kg
Operating Temperature	0 °C ~ 50 °C
Storage Temperature	-20 °C ~ 60 °C

SSD= Panel + LED Driving Board + AD Control Board + Housing

Specifications are subject to change without notice.
All brands or product names are trademarks or registered trademarks of their respective companies.



Mechanical Drawing

Outline Dimensions

Unit:mm

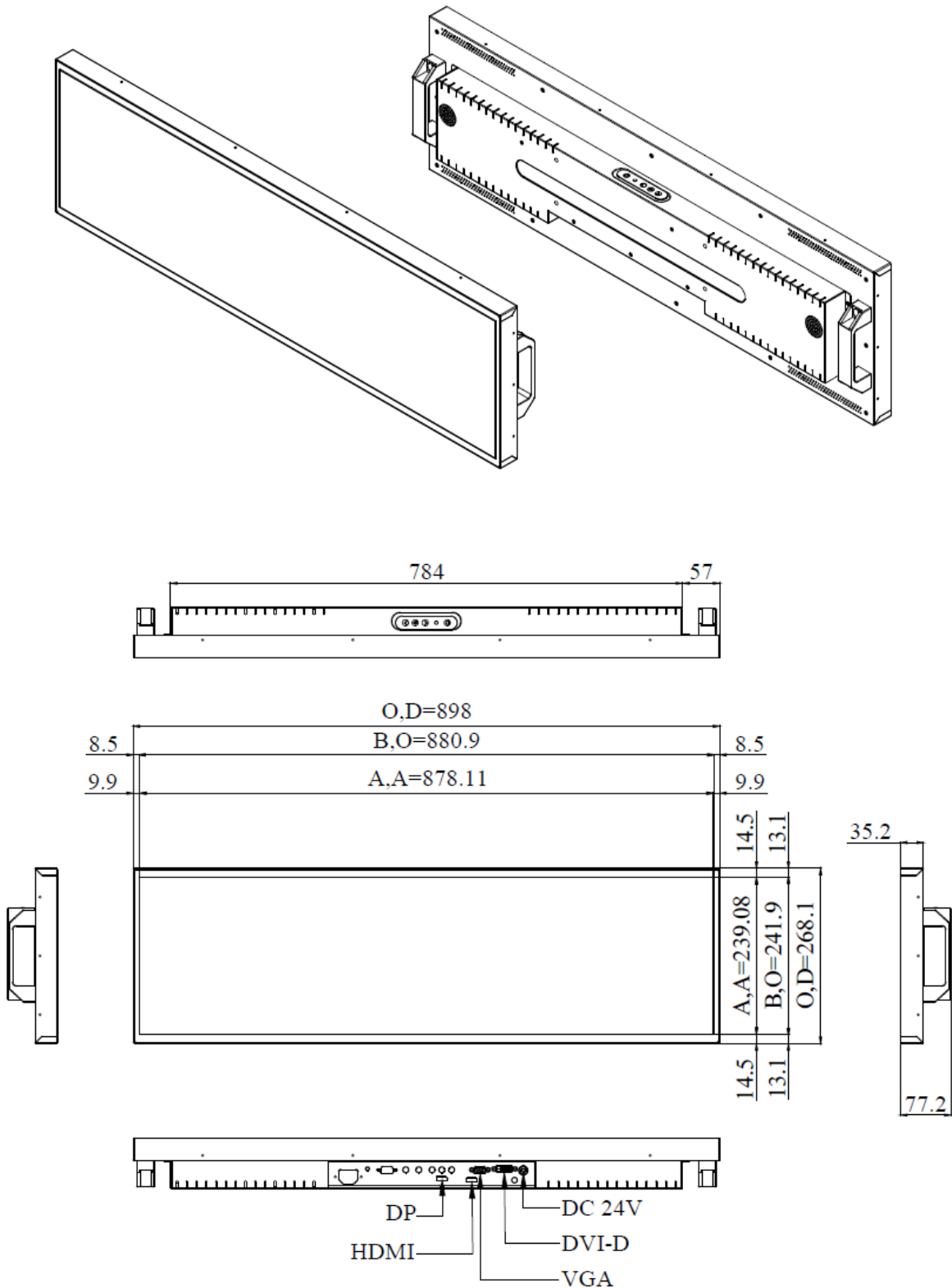

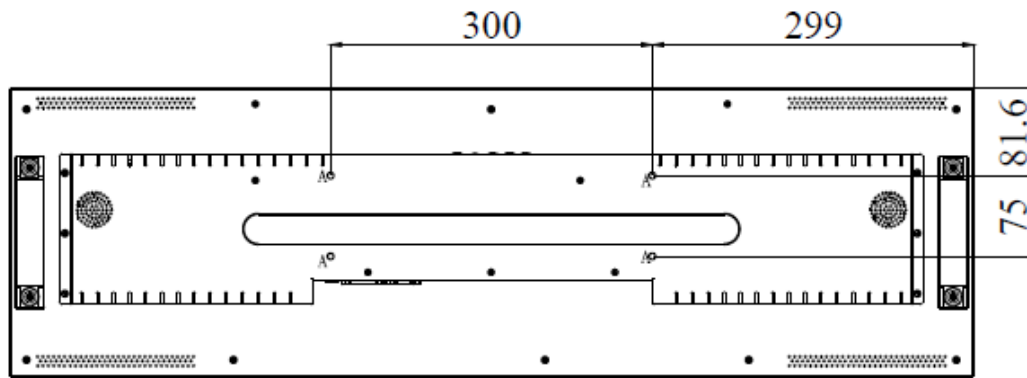

Note :

O.D : Outline Dimension(mm)

B.O : Bezel Opening

A.A : LCD Active Area

A:4-M6_USER HOLE_MAX DEPTH=6mm



Ordering Information

Part Number	Description
SSD3585-YNB-J11	35.8",1000nits,1920x532,LID on LCM,AD5827GDHP,O/B,speaker*2,DC24V,2in1,V1

Optional Accessories

Part Number	Description
810618301010	CABLE,POWER,AC,1830mm USA type
810618301090	CABLE,POWER,AC,1830mm Europe type
810618301050	CABLE,POWER,AC,1830mm UK type
810618301170	CABLE,POWER,AC,1830mm Australia type
810618301031	CABLE,POWER,AC,1830mm Japan type

Customer request

Touch	SCT (Single-Touch), PCT (Multi-Touch)
Glass	Tempered glass, AR coating.....